



Tilmar

informatieblad

TVR-S stalen toevoerventiel

Toepassing

Het stalen toevoerrooster TVR-s/t is geschikt voor toepassing in zowel natuurlijke als mechanische ventilatiesystemen.

Capaciteit

3—130 l/s

Uitvoering

Het TVR-s/t rooster is standaard gemoffeld in RAL-9010. Het rooster heeft hierdoor een glanzend en vuil afstotend oppervlak dat eenvoudig is te reinigen. De buitenring is voorzien van een schuimafdichting waardoor een luchtdichte aansluiting ontstaat.

Regelbaar

De luchthoeveelheid kan worden geregeld doordat de conus draaibaar is. Daarmee wordt de toevoeropening vergroot of verkleind. Zie de onderstaande grafieken voor de juiste instellingen.

Montage

Met montagering.

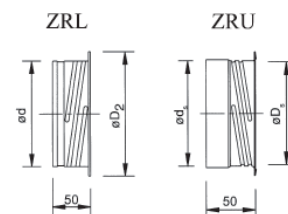
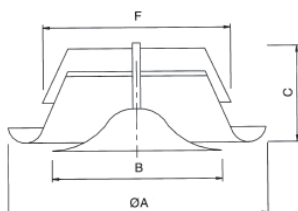

Size	ØA (mm)	B (mm)	C (mm)	F (mm)	Weight (g)
80	115	76	42	77,5	150
100	138	92	40	97,5	170
125	164	111	46	122,5	230
160	211	147	54	157,5	370
200	248	194	63	197,5	520

Size	Ød (mm)	ØD ¹ (mm)	ØD ² (mm)	ØDs (mm)	ØDs (mm)	ZR (g)	ZRTZRL/ ZRU (g)
80	79	-	105	-	-	-	80
100	99	125	125	100	98	50	100
125	124	155	150	125	123	65	120
160	159	186	185	160	158	100	190
200	199	230	225	200	198	140	240

model 80 is niet uit voorraad leverbaar

Geluidgegevens

Het geluidvermogeniveau in octaafband $L_{w,oct,dB}$ wordt verkregen door het geluidsdruk niveau L_{p10A} , dB(A) vanuit de grafieken toe te voegen aan de correctiefactor:

$$L_{w,oct} = L_{p10A} + K_{oct}$$

Correction factor in octave band K_{oct} (dB)

Size	Medium frequency (Hz)						
	125	250	500	1000	2000	4000	8000
80	2	2	1	0	-3	-9	-17
100	4	3	2	0	-7	-15	-30
125	2	7	3	-2	-10	-20	-32
160	5	7	3	-2	-10	-19	-32
200	8	6	4	-3	-10	-19	-32
Tol.±	3	2	2	2	2	2	3





Tilmar

Geluiddemping

De geluiddemping, ΔL , laat de reductie van het geluidvermogeniveau zien, berekend vanuit luchtkanaal naar de ruimte.

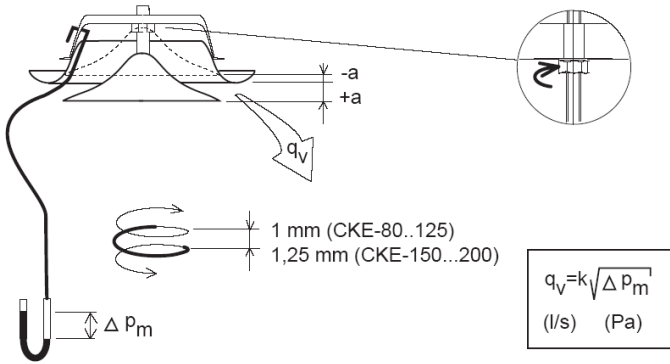

Sound attenuation

Size	Regulation (mm)	Medium frequency (Hz)							
		63	125	250	500	1000	2000	4000	8000
80	-3	24	21	16	12	9	7	5	5
	+3	24	19	13	10	7	4	4	4
	+9	24	19	13	9	6	3	3	4
100	-3	22	17	13	10	8	8	6	9
	+3	21	16	11	8	6	7	4	7
	+9	22	16	11	8	6	6	3	6
125	-9	22	16	11	8	6	5	6	7
	0	20	15	10	7	5	4	3	6
	+9	20	15	9	6	4	3	3	5
160	-3	18	14	9	7	6	7	6	8
	+6	18	13	8	6	5	5	6	6
	+12	18	13	8	5	4	4	5	6
200	0	16	12	9	8	9	9	9	8
	+9	16	11	8	6	7	7	7	7
	+15	17	11	7	6	6	5	6	6
Tol.±		6	3	2	2	2	2	2	3

TVR-s/t - 100, 4.5 l/s bij 1 Pa

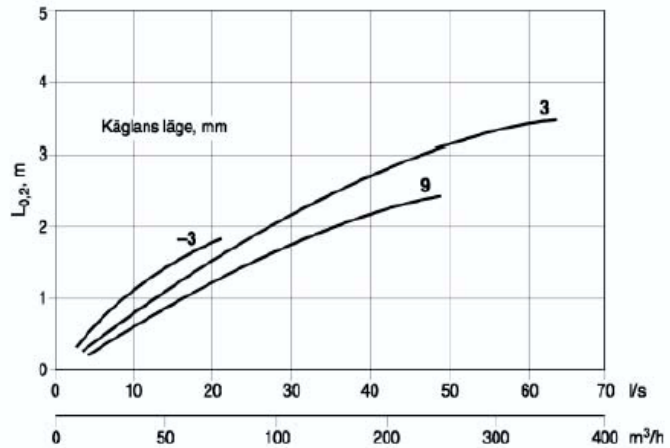
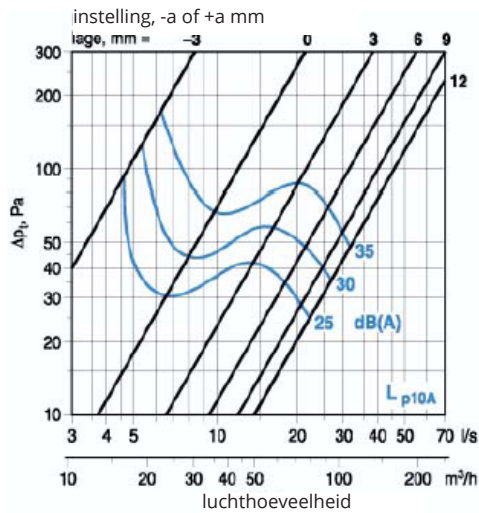

TVR-s/t - 125, 7.0 l/s bij 1 Pa

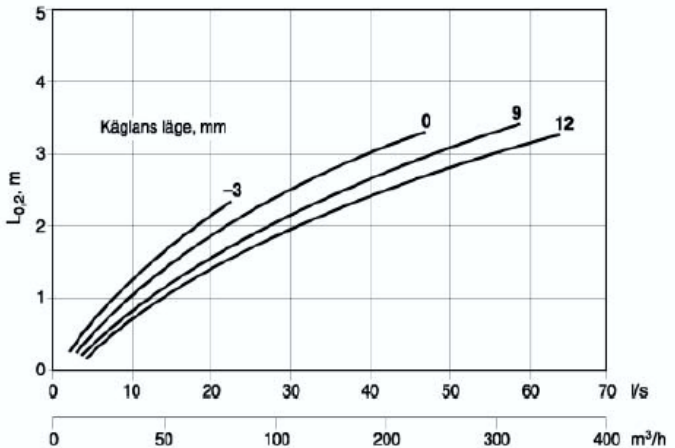
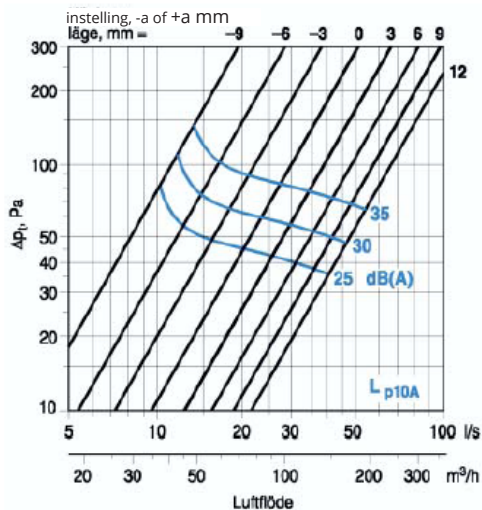



Tilmar

TVR-s/t - 160, 10.0 l/s bij 1 Pa

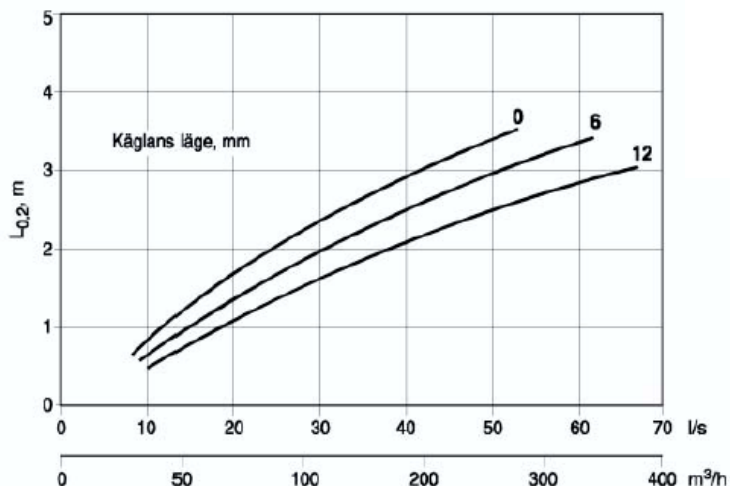
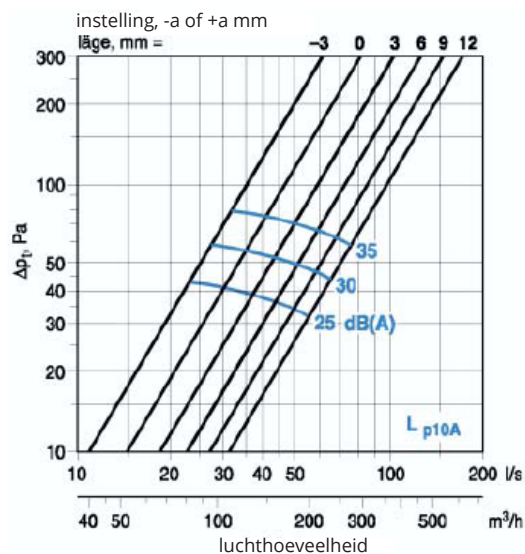

TVR-s/t - 200, 16.0 l/s bij 1 Pa

